



ONEMED

SURGICAL INSTRUMENTS

Ophthalmic Instruments Since 1991



OVERVIEW

ONEMED has been manufacturing Micro Ophthalmic Instruments Since 1991 and continuously supplying to our Partners Worldwide to meet the precise demands of clinics and hospitals.

QUALITY

Following the International norms of quality, our checking process is very strict to ensure the consistency at our exports. Generally we use the Pakistan made high grade Stainless Steel and German/Japanese too, Titanium & Tungsten Carbide to provide the desired accuracy and effectiveness in our entire range.

TEAM

The link between management, engineers and workers is our style to make proper functional instruments with advice of professional Ophthalmologists.

SERVICES

We regularly keep in touch with our worthy clients to exchange the production information and developments to achieve the international market competency.

It's a tribute, our company get the Forging out side from Pakistan and systematically re-finish the Forceps & Scissors to re-export our partner. The stipulate deliveries are main focus by **ONEMED** to obtain the associates appreciation and it's our valid success.



MED

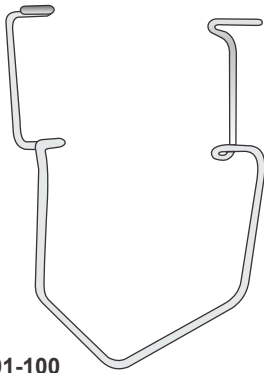

1M-01-100
KARTZ-BARRAQUER
Wire Speculum Angled Open Blades

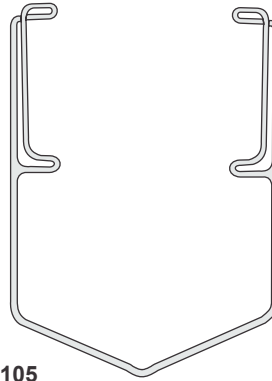

1M-01-105
BARRAQUER
Wire Speculum Fenestrated Blades

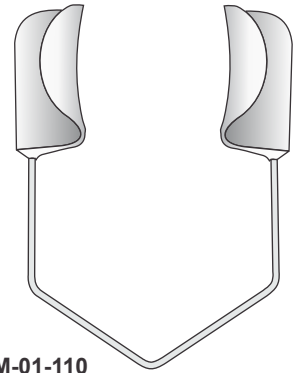

1M-01-110
BARRAQUER
Wire Speculum with Solid Blades

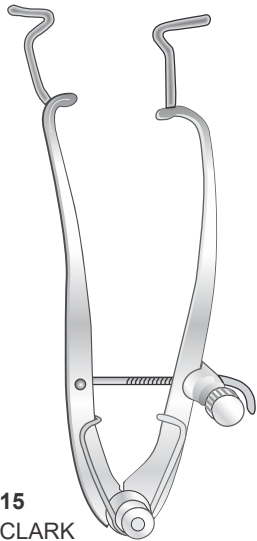

1M-01-115
KNAPP/CLARK
Adjustable Screw with Open Blades



1M-01-120
LEIBINGER
Adjustable Screw Round Wire Open Ends

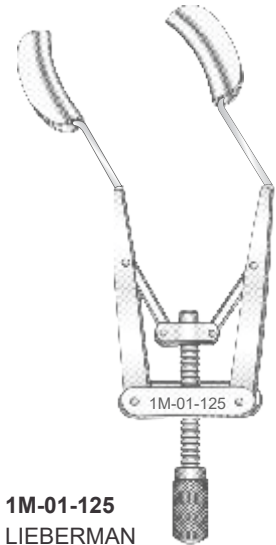

1M-01-125
LIEBERMAN
Adjustable Shaft Standard Solid Blades

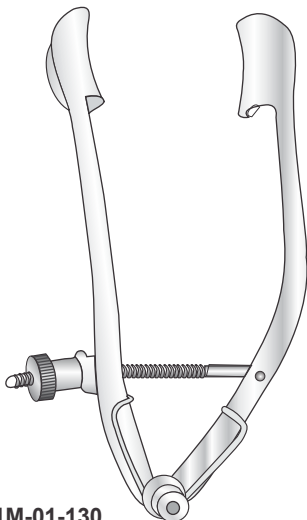

1M-01-130
LANCASTER
Adjustable Mechanism with Locking Nut



1M-01-135
MUELLER
Lacrimal Sa Retractor 3 x 3 Blunt Prongs

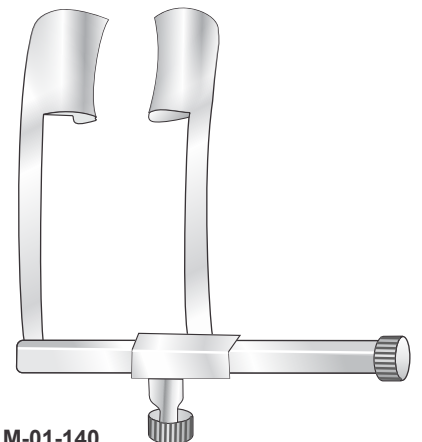

1M-01-140
COOK
Locking Screw Moving System Solid Blades

MED

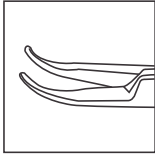

1M-02-145
BARRAQUER
 Needle Holder CVD Extra Delicate
 6 mm x 0.6 mm Jaws, Length 12.5 cm

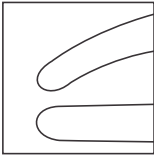
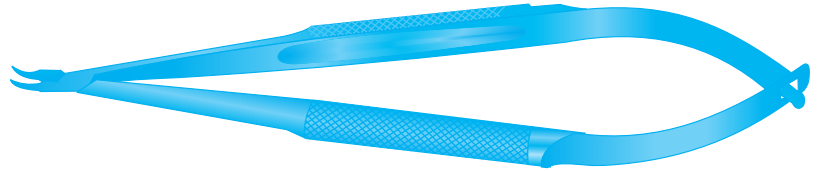

1M-02-150
CASTROVIEJO
 Needle Holder STR with Lock
 Length 14 cm

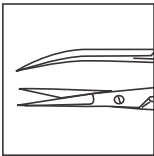
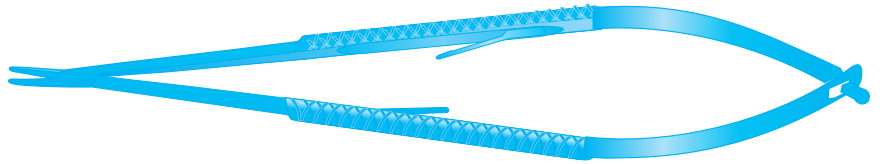

1M-02-155
CASTROVIEJO
 Universal Micro Scissors CVD
 Length 14 cm

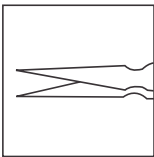
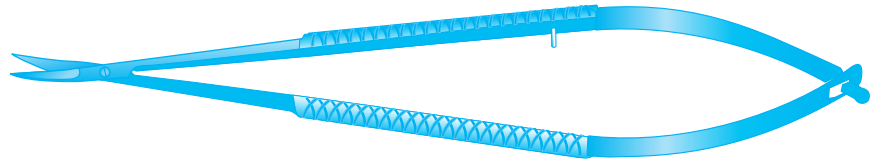

1M-02-160
GILLS-VANNAS
 Capsulotomy Scissors STR Sharp Blades
 7 mm, Length 8.5 cm

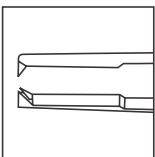
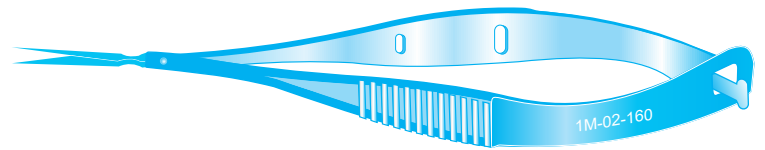

1M-02-165
BONN
 Corneal Utility Forceps 1:2 of 0.3 mm &
 6 mm Tying Platform, Length 9.5 cm

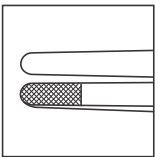
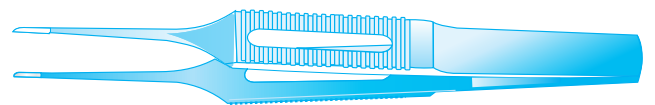

1M-02-170
BISHOP-HARMON
 Dressing Forceps Criss-Cross
 Serrated Tips, Length 9 cm

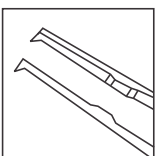

1M-02-175
UTRATA
 Capsulorhexis Forceps ANG Ultra
 Fine Grasping Tips, Length 10.5 cm



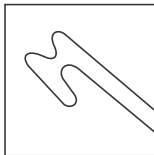

1M-03-180
HIRSCHMAN
Iris Hook 9 mm Angled Shaft
& Blunt 0.75 mm Hook

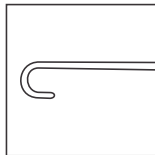

1M-03-185
BONN
Iris Hook Extra Delicate
0.3 mm Blunt

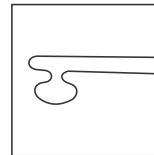

1M-03-190
KUGLEN
Lens Push and Pull Manipulator
0.4 mm Ball & 0.8 mm Finger

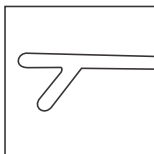

1M-03-195
MALTMAN-FENZL
IOL Manipulator Hook
V-Shape 0.7 mm Tip

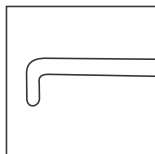

1M-03-200
SINSKY
IOL Manipulator Hook
0.5 mm Blunt

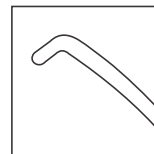

1M-03-205
LEWICKY
IOL Manipulator Hook
0.3 mm Blunt

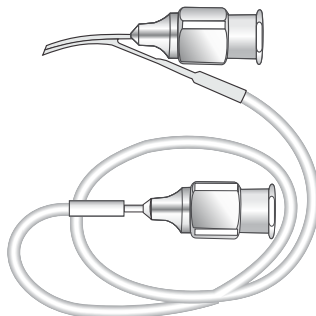
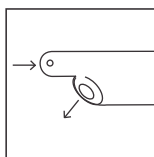

1M-03-210
SIMCOE
Irrigating/Aspirating
Cannula with Silicon Tube



1M-03-215
JENSEN
Lacrimal Cannula Bulbous End



1M-03-220
DAMPEN
Irrigating Straight Blunt Tip Cannula

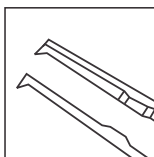

1M-03-225
UTRATA
Capsulorhexis Forceps 11mm
angled Fine Grasping Tips, 10.5cm

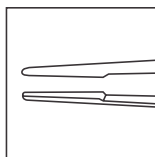

1M-03-230
McPHERSON
Tying Forceps with 7 mm
Platform, Length 10.5 cm

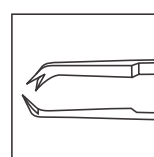

1M-03-235
SINDER
Castroviejo Suturing Forceps 1:2
set at 45 Degree with Platform

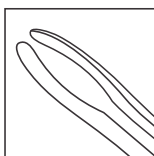

1M-03-240
SPALECK
Insertion Forceps for Acrylic
& Silicone Lens, Length 10.5 cm

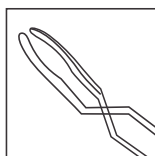

1M-03-245
ERNEST
IOL Insertion Forceps
Cross Action 10.5 cm

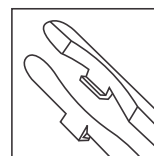

1M-03-250
LIVERNOIS
Folding Forceps for Acrylic
Lens Concave Jaw Surfaces



MED

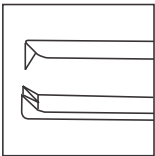

1M-04-255
GRAEFE
Iris Forceps 1:2 Teeth,
Length 6.5 cm

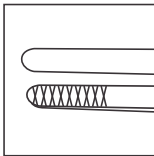

1M-04-260
GRAEFE
Iris Forceps Serrated Jaws,
Length 6.5 cm

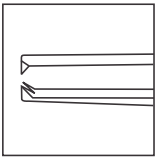

1M-04-265
BISHOP-HARMON
Tissue Forceps 1:2 Teeth,
Length 8.5 cm

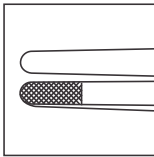

1M-04-270
BISHOP-HARMON
Dressing Forceps Criss-Cross
Serrated Tip

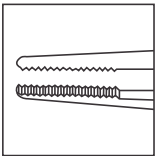

1M-04-275
BONN
Micro Iris Forceps Serrated
Ultra Fine Shanks

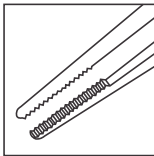

1M-04-280
BONN
Micro Iris Forceps Angled
Ultra Fine Shanks, Length 7.3 cm

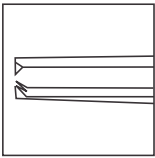

1M-04-285
BONN
Micro Iris Forceps STR Ultra
Fine Shanks 1:2 Teeth 0.3 mm

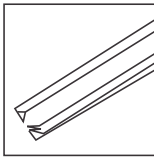

1M-04-290
BONN
Micro Iris Forceps CVD Fine
Shanks 1:2 Teeth 0.3 mm

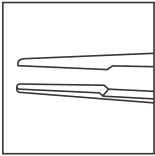

1M-04-295
BONN
Tying Spreading Forceps STR
Ultra Fine Platform 5 mm

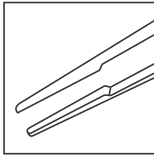

1M-04-300
BONN
Tying Spreading Forceps ANG
Ultra Fine, Length 7.3 cm

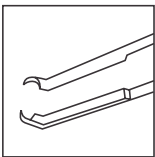

1M-04-305
PIERSE
Corneal Suturing Forceps
1:1 Pierce Teeth,
Length 7.5 cm Pierce

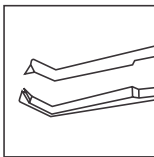

1M-04-310
COLIBRI
Corneal Suturing Forceps 1:2 at
90 Degree, Length 7 cm

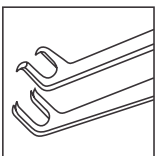

1M-04-315
POLACK
Corneal Suturing Forceps
U-shaped 1:2 & 1 mm Spread

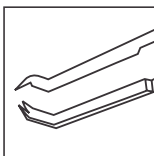

1M-04-320
COLIBRI
Corneal Suturing Forceps 1:2 at
45 Degree, Length 7 cm



MED

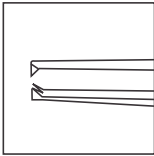

1M-05-325
DELICATE
 Tissue Forceps 1:2 Teeth
 0.6 mm, Length 10 mm

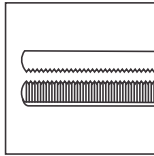

1M-05-330
DELICATE
 Dressing Forceps Serrated
 Fine Tip, Length 10 mm

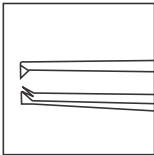

1M-05-335
ADSON
 Micro Forceps 1:2 Teeth
 0.4 mm, Length 12 cm

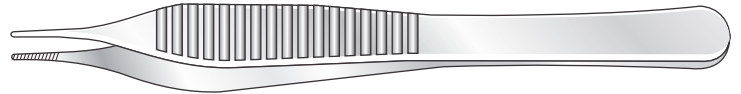
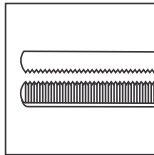

1M-05-340
ADSON
 Micro Forceps Delicate
 Serrated, Length 12 cm

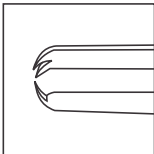

1M-05-345
KUHNT
 Scleral Fixation Forceps 1:2
 CVD Teeth, Length 11 cm

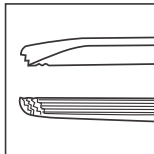

1M-05-350
BONACCOLTO
 Conjunctival Fixation Forceps Longitudinally
 Serrated & Cross Serrated Tip

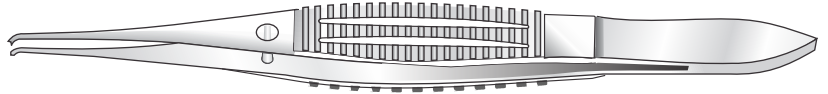
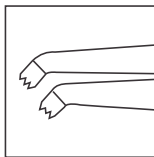

1M-05-355
BORES
 Incision Spreading Forceps Micro Serrated 5 mm Tip

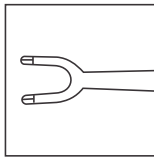

1M-05-360
BORES
 Corneal Fixation Forceps 3 mm U Shaped 0.12 mm Teeth at Tips,

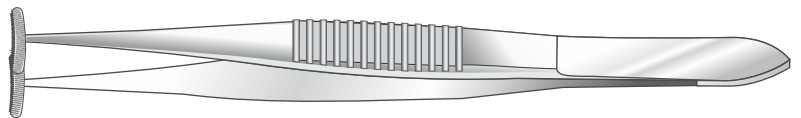
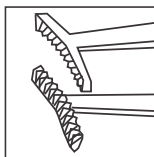

1M-05-365
GREEN
 Globe Fixation Forceps with Multiple Teeth, 10 cm

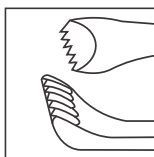

1M-05-370
GRAEFE
 Globe Fixation Forceps 6:7 Teeth, Length 11 cm

MED

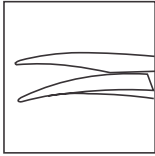

1M-06-375
CASTROVIEJO
Corneal Scissors CVD
12 mm Blades & Sharp Tips

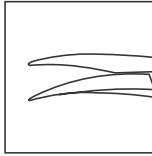

1M-06-380
CASTROVIEJO
Corneal Scissors CVD 12 mm
Blades & Blunt Tips

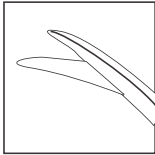

1M-06-385
CASTROVIEJO
Corneal Section Scissors 11 mm
Blades Curved to Right

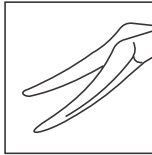

1M-06-390
CASTROVIEJO
Corneal Section Scissors 11 mm
Blades Curved to Left



1M-06-400
RICH
Corneal Transplant Scissors Delicate
Blades Strong Curved to Right

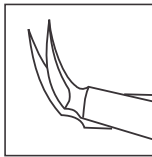

1M-06-405
RICH
Corneal Transplant Scissors Delicate
Blades Strong Curved to Left

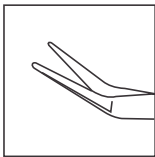

1M-06-410
CASTROVIEJO
Keratoplasty Scissors Angled
to Side Small Blades Blunt Tips

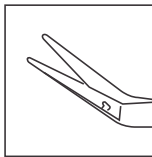

1M-06-415
CASTROVIEJO
Corneal Scissors Angled to Side
14 mm Large Blades Blunt Tips

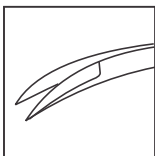

1M-06-420
McPHERSON-VANNAS
Micro Iris Scissors CVD Blades
with Sharp Tips

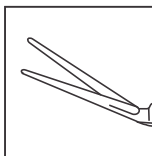

1M-06-425
ONG
Capsulotomy Scissors Angled
and Straight Blades



1M-06-430
GILLS-VANNAS
Capsulotomy Scissors
Angled to Side Blades

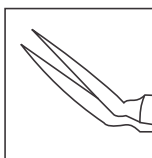

1M-06-435
GILLS-VANNAS
Capsulotomy Scissors
Angled Forward Blades

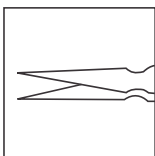

1M-06-440
GILLS-VANNAS
Capsulotomy Scissors
Angled Straight Blades

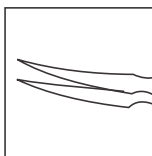

1M-06-445
GILLS-VANNAS
Capsulotomy Scissors
Angled Curved Blades

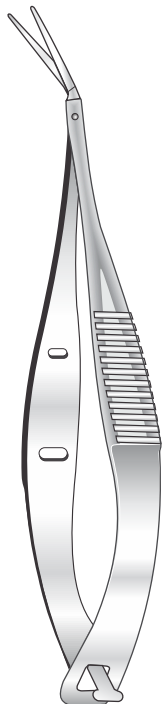
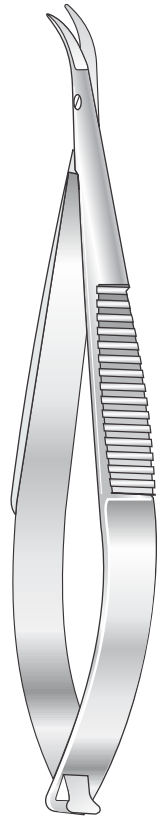



MED

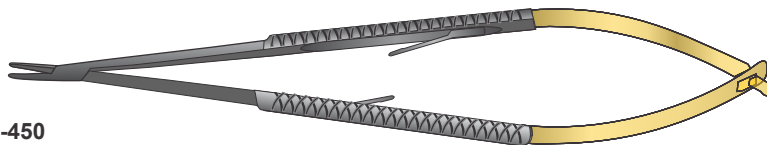
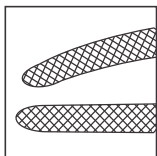

1M-07-450
BARRAQUER
Micro Needle Holder points
m/o Tungsten Carbide (TC)

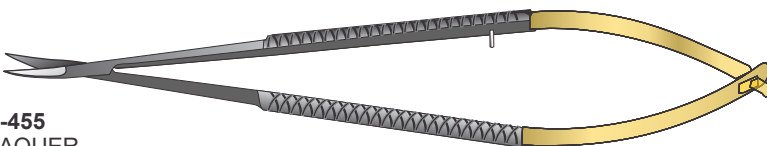
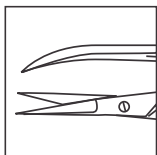

1M-07-455
BARRAQUER
Micro Scissors points
m/o Tungsten Carbide (TC)

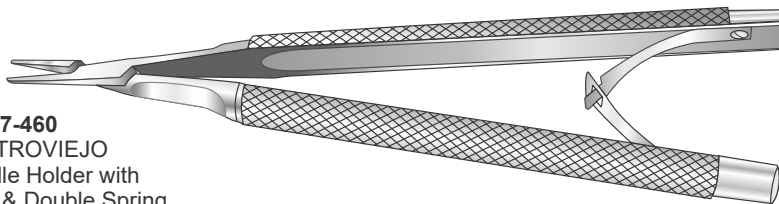
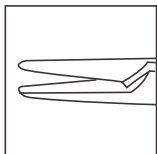

1M-07-460
CASTROVIEJO
Needle Holder with
Lock & Double Spring

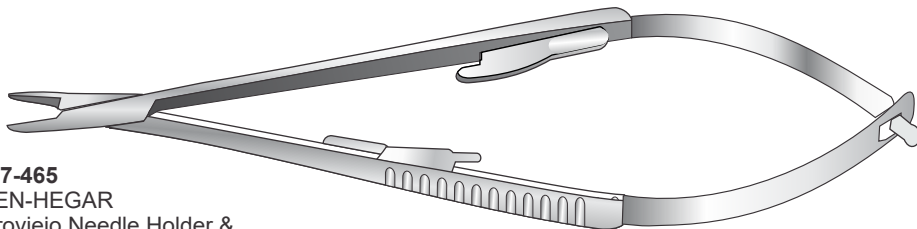
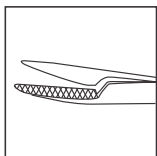

1M-07-465
OLSEN-HEGAR
Castroviejo Needle Holder &
Scissors with Lock, 14 cm

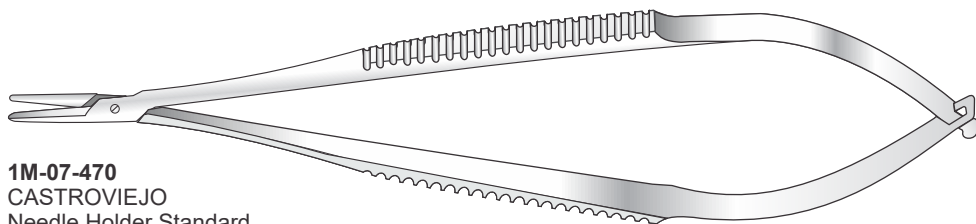
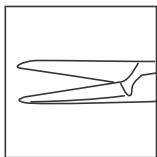

1M-07-470
CASTROVIEJO
Needle Holder Standard
11 mm x 1.2 mm Jaws

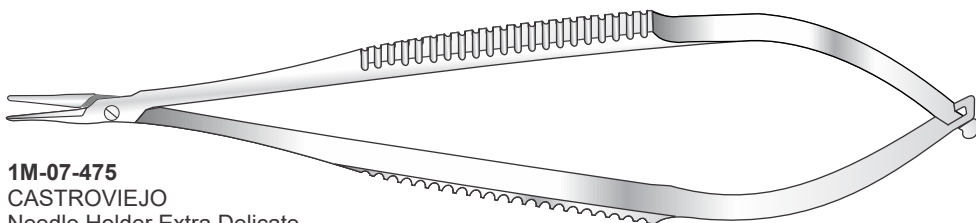
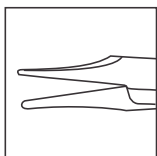

1M-07-475
CASTROVIEJO
Needle Holder Extra Delicate
10 mm x 0.6 mm Jaws, 14 cm



MED

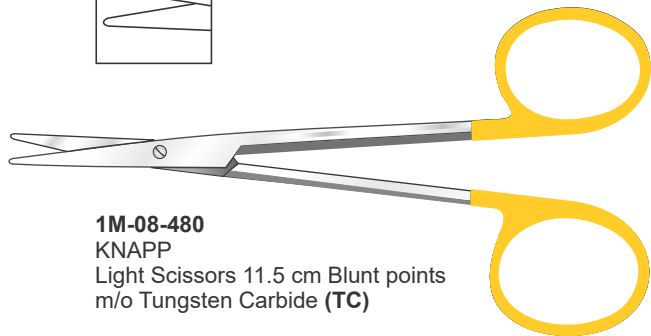
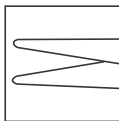

1M-08-480
KNAPP
Light Scissors 11.5 cm Blunt points
m/o Tungsten Carbide (TC)

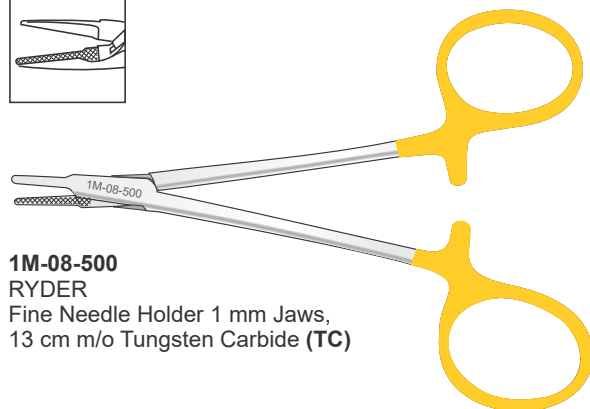
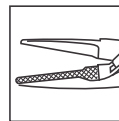

1M-08-500
RYDER
Fine Needle Holder 1 mm Jaws,
13 cm m/o Tungsten Carbide (TC)

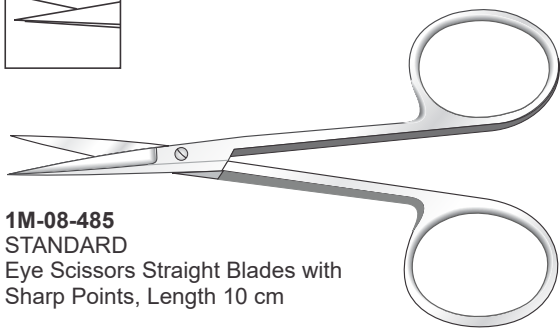
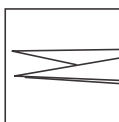

1M-08-485
STANDARD
Eye Scissors Straight Blades with
Sharp Points, Length 10 cm

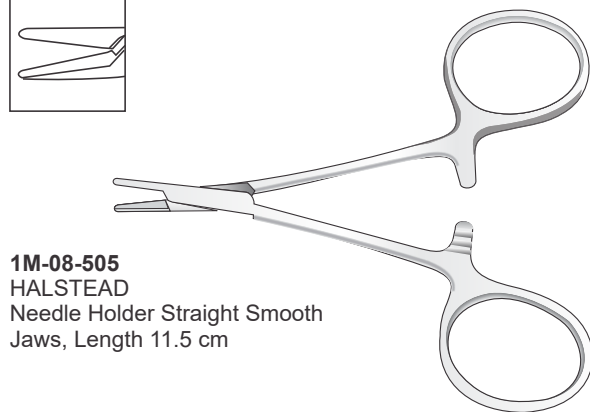
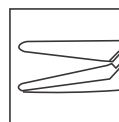

1M-08-505
HALSTEAD
Needle Holder Straight Smooth
Jaws, Length 11.5 cm

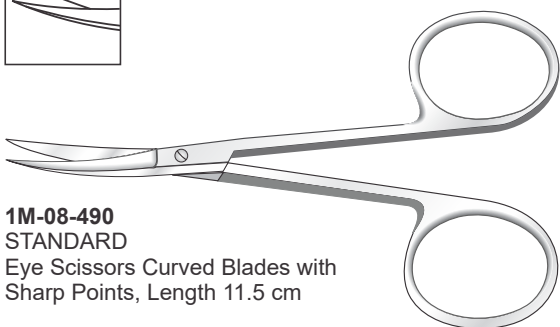

1M-08-490
STANDARD
Eye Scissors Curved Blades with
Sharp Points, Length 11.5 cm

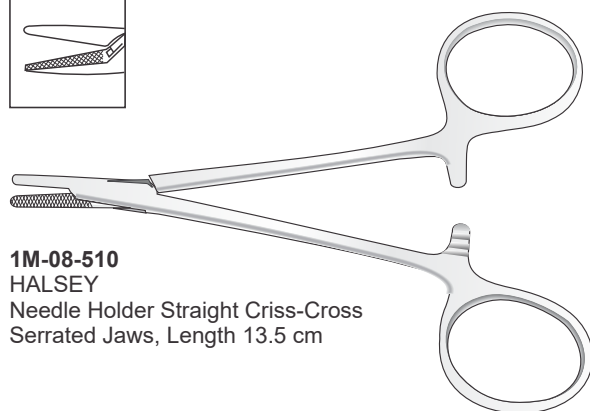
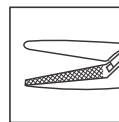

1M-08-510
HALSEY
Needle Holder Straight Criss-Cross
Serrated Jaws, Length 13.5 cm

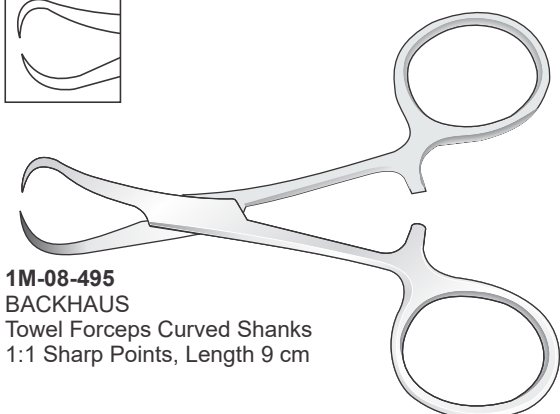

1M-08-495
BACKHAUS
Towel Forceps Curved Shanks
1:1 Sharp Points, Length 9 cm

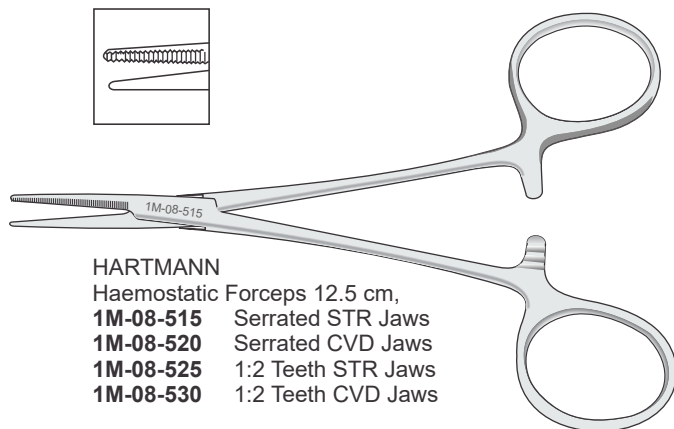
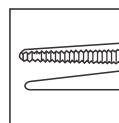

HARTMANN
Haemostatic Forceps 12.5 cm,
1M-08-515 Serrated STR Jaws
1M-08-520 Serrated CVD Jaws
1M-08-525 1:2 Teeth STR Jaws
1M-08-530 1:2 Teeth CVD Jaws



MED

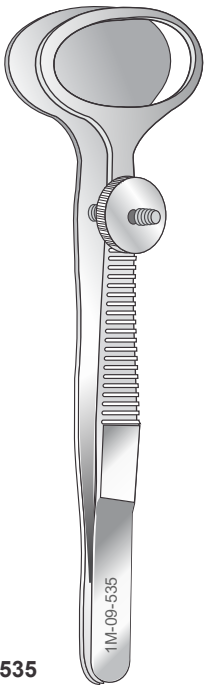

1M-09-535
DESMARRES
Chalazion Forceps Oval Blades
20 mm Blades, 9 cm

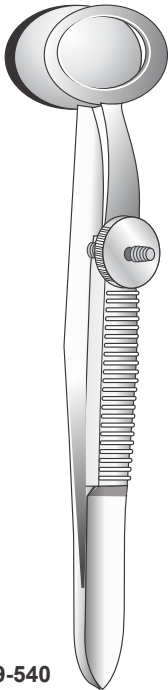

1M-09-540
FRANCIS
Chalazion Forceps Oval Blades
12x14 mm Dia, 9.5 cm

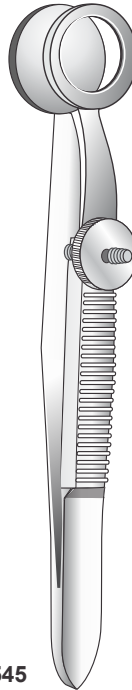

1M-09-545
HUNT
Chalazion Forceps Round
Blades 12 mm Dia, 9.5 cm

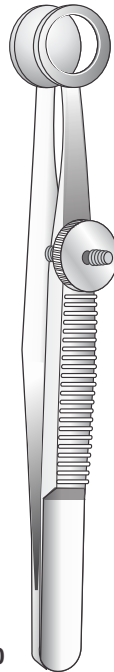

1M-09-550
LAMBERT
Chalazion Forceps Round
Blades 8 mm Dia, 9 cm



1M-09-555
FIGURE-5A
Suture Removal Forceps Very
Fine Pointed Tips, 11.5 cm



1M-09-560
FIGURE-3C
Jewelers Forceps Straight
Delicate Tips, 12 cm

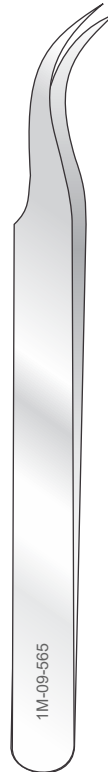

1M-09-565
FIGURE-7
Jewelers Forceps Curved
Delicate Tips, 11.5 cm



1M-09-570
FIGURE-5
Jewelers Forceps 45 Degree
Angled Ultra Fine Tip, 11 cm

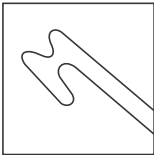
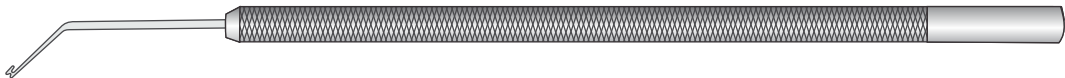

1M-10-575
HIRSCHMAN
Iris Hook 9 mm Angled
Shaft & Blunt 0.75 mm Hook

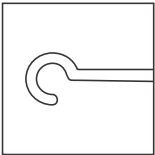

1M-10-580
SHEPARED
Iris Hook Small with 1.0 mm
Hook, Length 12 cm

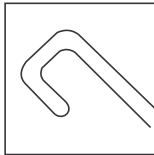

1M-10-585
OSHER
Iris Hook 10 mm Angles
Shaft & 1.5 mm Blunt Hook

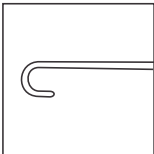

1M-10-590
BONN
Micro Iris Hook Very Delicate
0.3 mm Blunt Hook

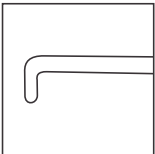

1M-10-595
SINSKY-II
IOL Manipulating Hook
0.2 mm Dia & Blunt Tip

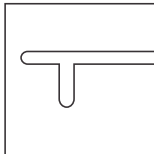

1M-10-600
FENZL
Lens Manipulating Hook
0.15 mm Dia Blunt T-Tip, 12 cm

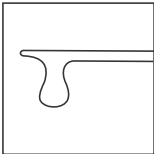

1M-10-605
LESTER
Lens Pusher Shaft with 0.25 mm
Dia Hour-Glass Shape Tip

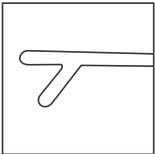

1M-10-610
MALTMAN-FENZL
Lens Manipulating 0.15 mm
Dia Blunt V-Shape

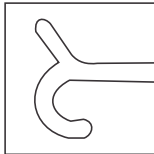

1M-10-615
RENTSCH
Lens Manipulating Hook &
Iris Retractor with Blunt Tips

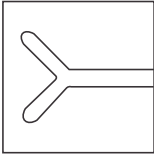

1M-10-620
OSHER
Lens Manipulating Hook
Y-Shape with Blunt Tips, 12 cm

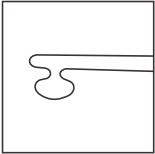

1M-10-625
KUGLEN
Iris Hook / Push & Pull
Manipulator Bulbous Hook

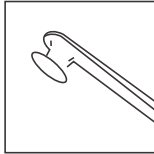

1M-10-630
GREATHER
Multifunctional Manipulator
(Iris/Capsule Retractor/Pusher)

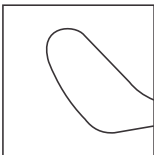

1M-10-635
BONN
Scleral Resection Knife
4 mm, Length 12.5 cm

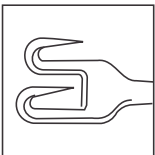

1M-10-640
GUTHRIE
Double Fixation Hook with
Sharp Prongs, 13 cm

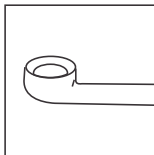

1M-10-645
MEYHOFER
Chalazion Curette Sharp
Round Cup, 12.5 cm

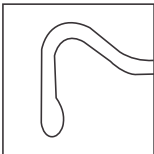

1M-10-650
JAMESON
Muscle Hook 2 mm
Bulbous Tip, Length 12 cm

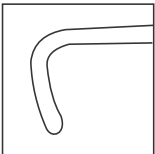

1M-10-655
STEVENS
Tenotomy Hook with
6 mm Curved Blunt Tip

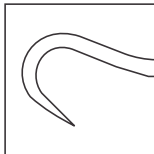

1M-10-660
TYRELL
Iris Hook Sharp Pointed,
Length 12.5 cm



MED



1M-11-665
 DESMARRES
 Lid Retractor Solid Blade, Length 14 cm

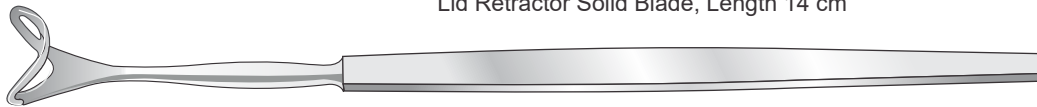

1M-11-670
 DESMARRES
 Lid Retractor Fenestrated Blade, Length 14 cm



1M-11-675
 KNAPP
 Lacrimal Sac Retractor Four Prongs, Length 13.5 cm



1M-11-680
 SNELLEN
 Lens Loop 15x4 mm Smooth, Length 14 cm



1M-11-685
 KIMURA
 Platinum Spatula Ultra Thin Flat Blade, 14.5 cm



1M-11-690
 CASTROVIEJO
 Cyclodialysis Spatula 0.5 mm Wide
 10x15 mm Long Blades & Blunt Tips

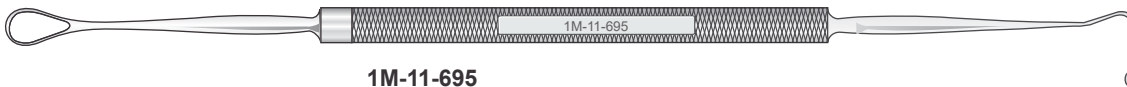

1M-11-695
 KIRBY
 Lens Loop 5 mm Dia and Expressor Hook, 14.5 cm



1M-11-700
 MORRISON
 Lens Loop & Probe, Length 14.5 cm



1M-11-705
 K-HANDLE
 Scalpel Handle No. 7

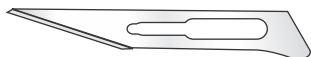

1M-11-711
 BLADE-1
 Scalpel Blade No. 11



1M-11-715
 BLADE-2
 Scalpel Blade No. 15



MED

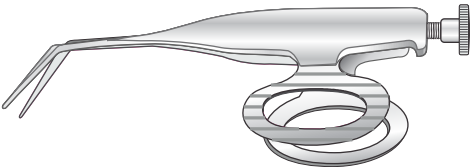

1M-12-720
BARRAQUER
Iridectomy Scissors 11x1.2 mm
Blades, Length 5.5 cm

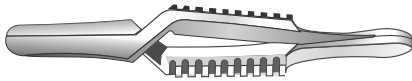

1M-12-725
DIEFFENBACH
Bulldog Clamp STR
serrated Jaws, 5 cm

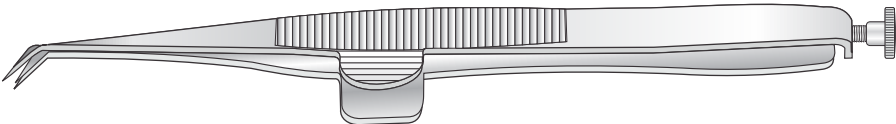

1M-12-730
DeWECKER
Iridectomy Scissors 11x1.2 mm Blades, Length 11 cm

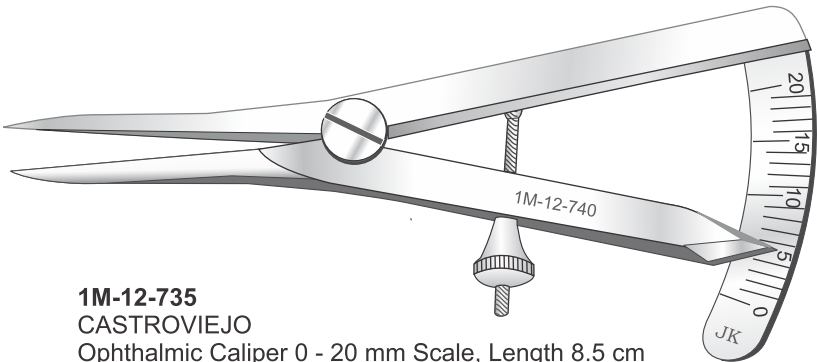

1M-12-735
CASTROVIEJO
Ophthalmic Caliper 0 - 20 mm Scale, Length 8.5 cm



1M-12-740
WILDER
Lacrimal Dilator Extra Fine Taper, Length 10 cm



BOWMAN
Lacrimal Probe Cylindrical, Malleable
1M-12-745 SS 00 & 0
1M-12-750 SS 1 & 2
1M-12-755 SS 3 & 4

EC REP

IBC - Sweden
14550 Norsborg
Stockholm Sweden
SE - AR - 000001625



EU MDR 2017/745
Certificate # IBC 02108161
SRN PK-MF-000011694



Food and Drug
Administration
FEI: 3015683639



The Surgical Instruments
Manufacturers Association
of Pakistan (Reg # 0039)

ONEMED

SURGICAL INSTRUMENTS

 **PO Box No. 1 Jinnah Park
Colony 2, Sialkot-51310
Pakistan**

 **+92 - 52 - 459 5335
+92 - 52 - 456 6209**

 **info@onemedurgical.com**

 **www.onemedurgical.com**

